

Series 4. Fridge/freezer

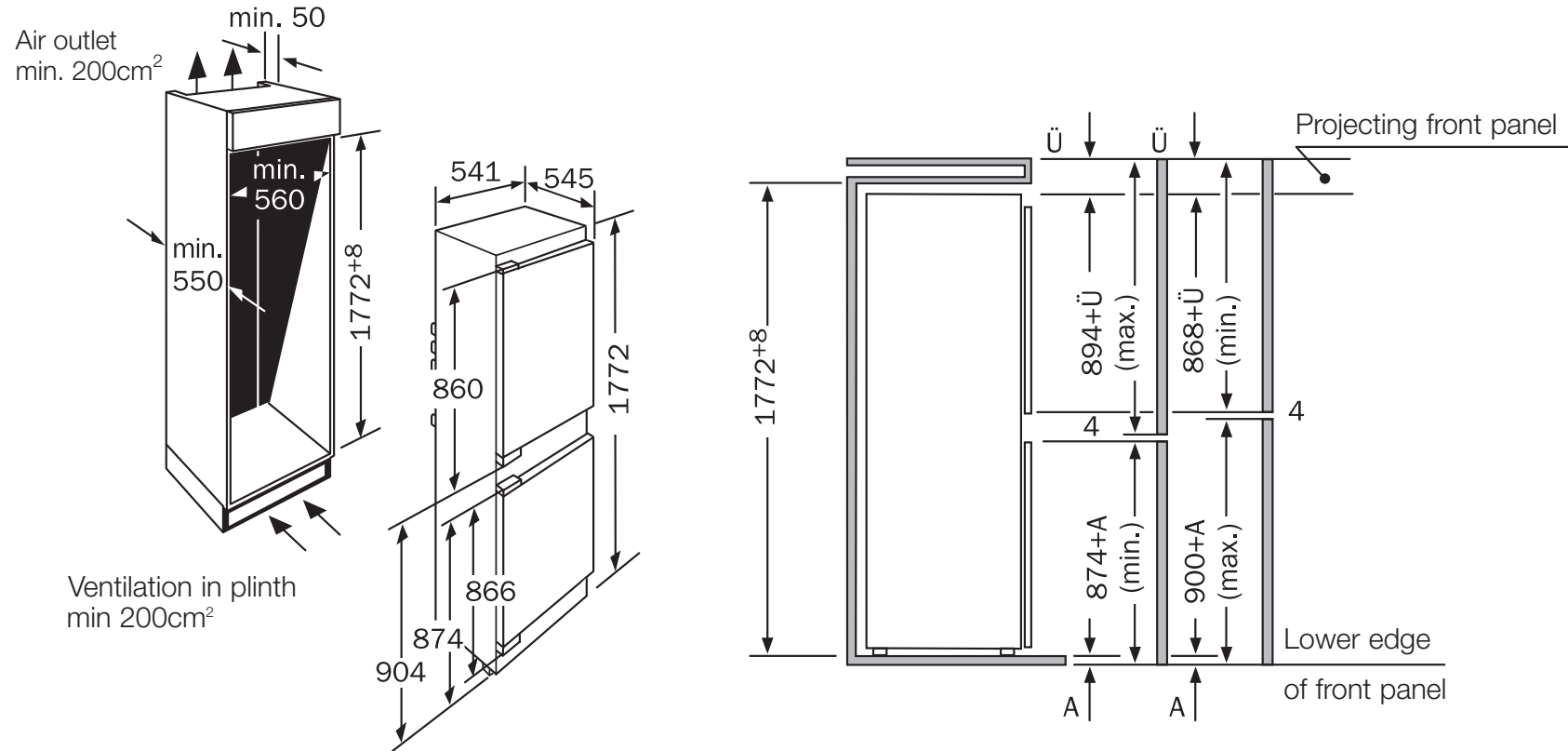

K4254



The line drawings are provided as a guide to general dimensions only and are subject to amendment without prior notice. For full dimensional and installation details please refer to the documentation supplied with the appliance.